

负温度系数(NTC)热敏电阻器

Negative Temperature Coefficient (NTC) Thermistor

CWF精密型NTC温度传感器系列

CWF Precision NTC Temperature Sensor Series

● 应用范围 Applications

应用于储能, 汽车、医疗、电动工具、家用电器, 通讯信息, 工业自动化等场合的温度测量与控制。

Used for temperature measurement and control in applications such as energy storage, automotive, medical, power tools, household appliances, communication systems, industrial automation, etc.

● 特点

- 采用全新工艺、产品性能稳定, 可长期工作
- 电阻值和B值精度高、一致性好、可互换
- 灵敏度高、反应迅速
- 具有良好的绝缘密封性和抗机械碰撞、抗折弯能力、可靠性高

● Features

- Utilizing Advanced Manufacturing Processes, the Product Demonstrates Stable Performance and is Capable of Long-Term Operation.
- High Resistance and B-Value Accuracy, Excellent Consistency, and Interchangeability.
- High Sensitivity and Rapid Response.
- Excellent Insulation and Sealing Properties, Resistance to Mechanical Impact and Bending, High Reliability.

● 产品标志说明 Marking Instruction

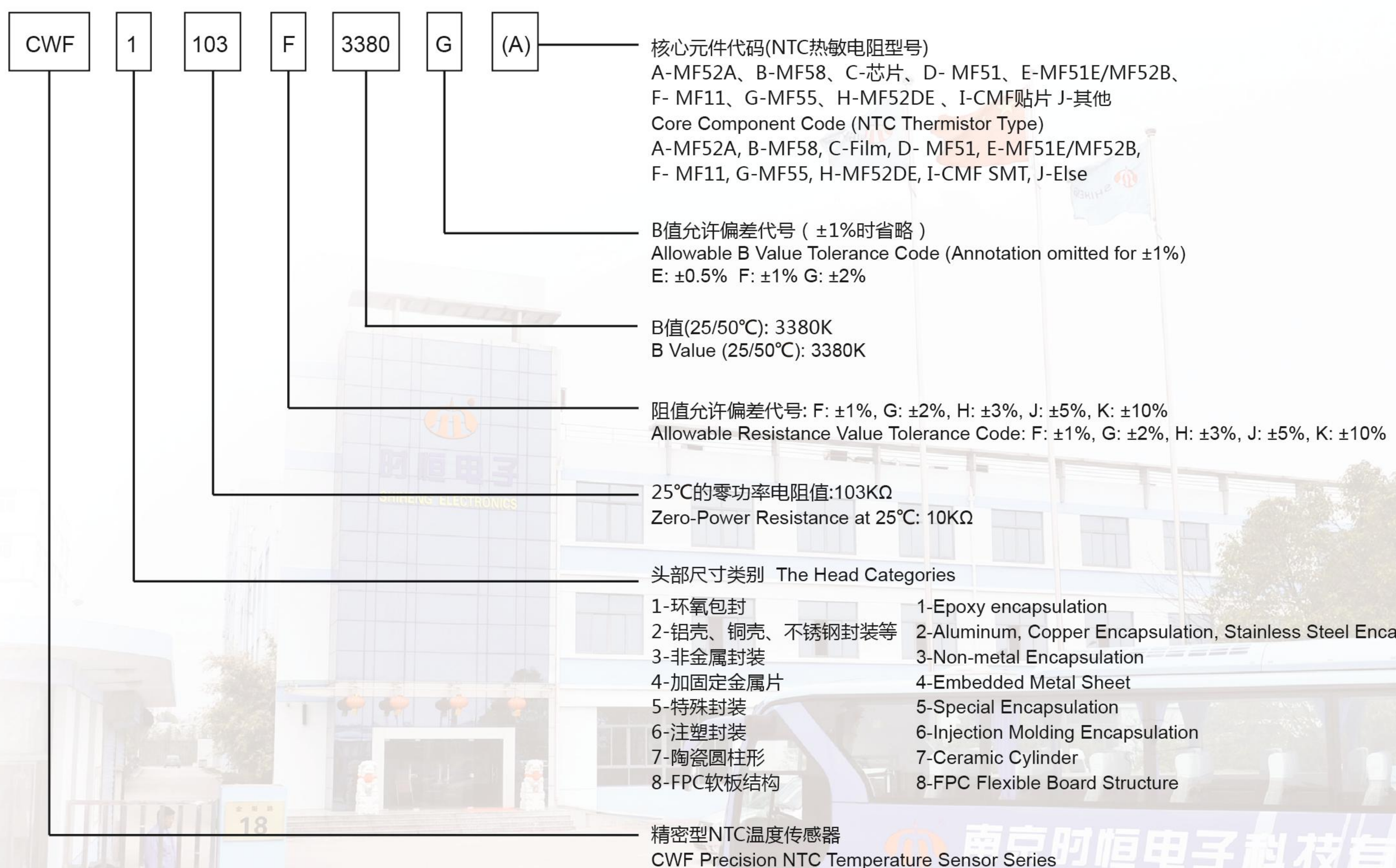

核心测温元件通过UL,CQC,TUV认证及AEC-Q200检测

The temperature-sensing component has obtained certifications from

UL, CQC, TUV and has passed AEC-Q200 testing



江苏省高新技术产品  
High-tech product in Jiangsu Province

● 安规认证 Certifications



UL1434认证  
UL1434 Certification  
(File# E240991)



CQC 认证  
CQC Certification  
(File# 10001052282)

CWF精密型NTC温度传感器系列  
CWF Precision NTC Temperature Sensor Series

CWF1 环氧包封  
CWF1 Epoxy encapsulation

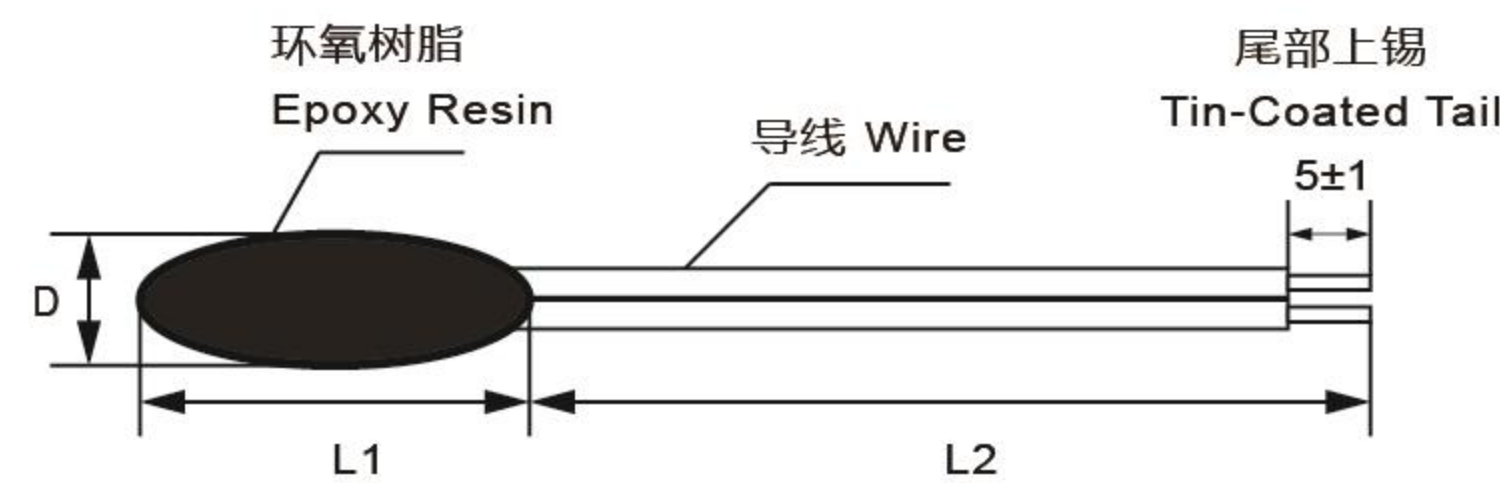

D L1 L2 用户确定 To be determined by the user

CWF2 铝壳、铜壳、不锈钢壳封装  
CWF2 Aluminum, Copper, Stainless Steel Encapsulation

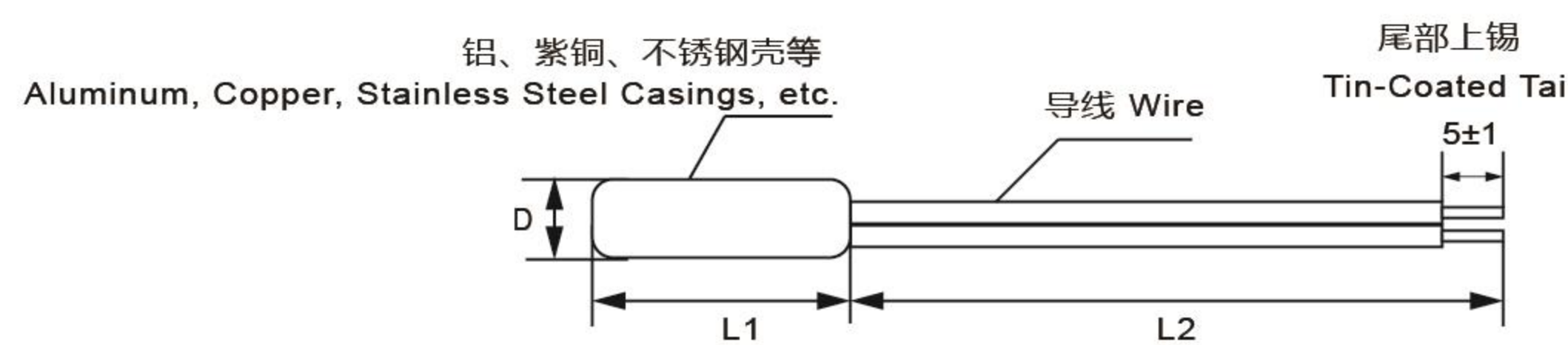

D L1 L2 用户确定 To be determined by the user

CWF3 非金属封装  
CWF3 Non-metal Encapsulation

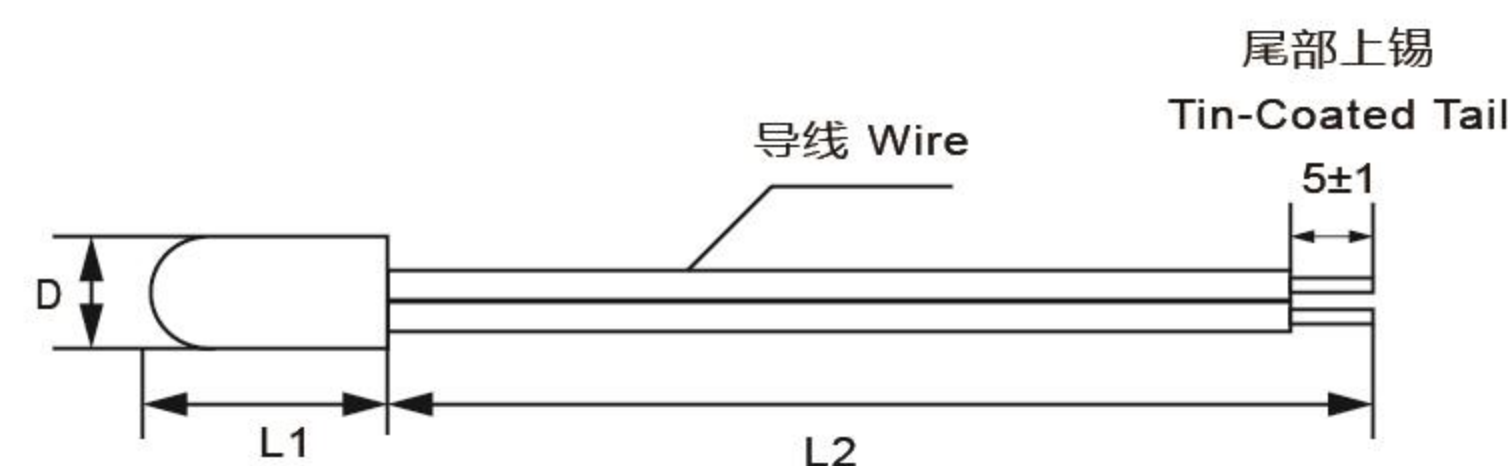

D L1 L2 用户确定 To be determined by the user

CWF4 加固定金属片  
CWF4 Embedded Metal Sheet

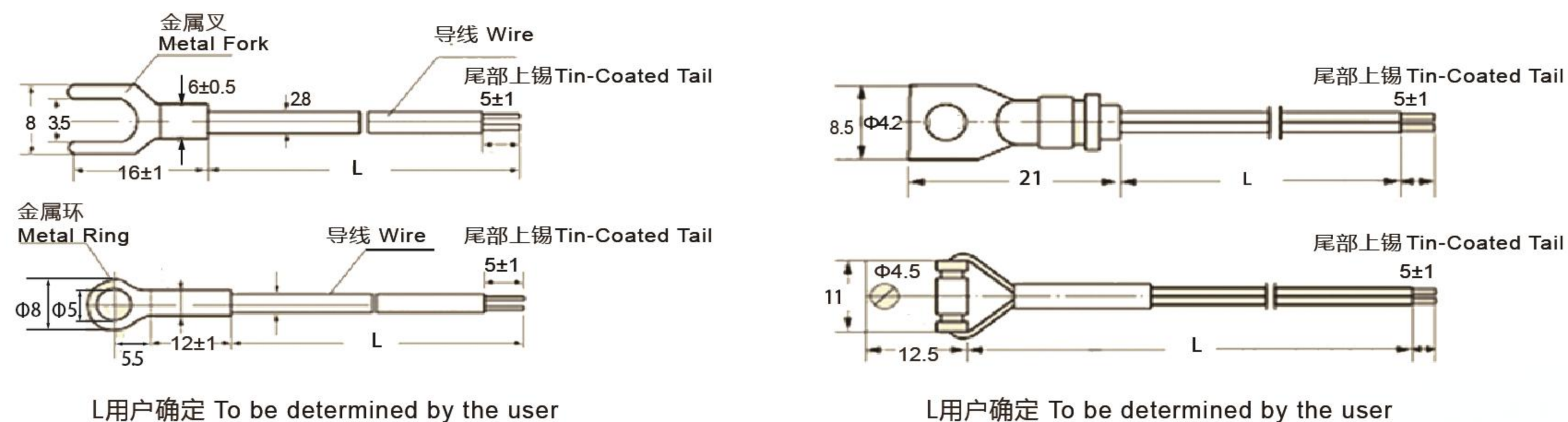

L用户确定 To be determined by the user

L用户确定 To be determined by the user

CWF5 加特殊封装  
CWF5 Special Encapsulation

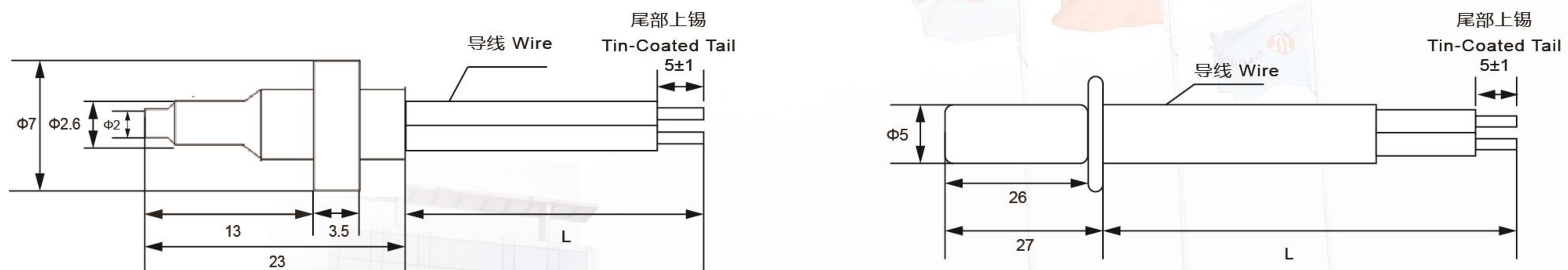

L用户确定 To be determined by the user

L用户确定 To be determined by the user

CWF6 注塑封装  
CWF6 Injection Molding Encapsulation

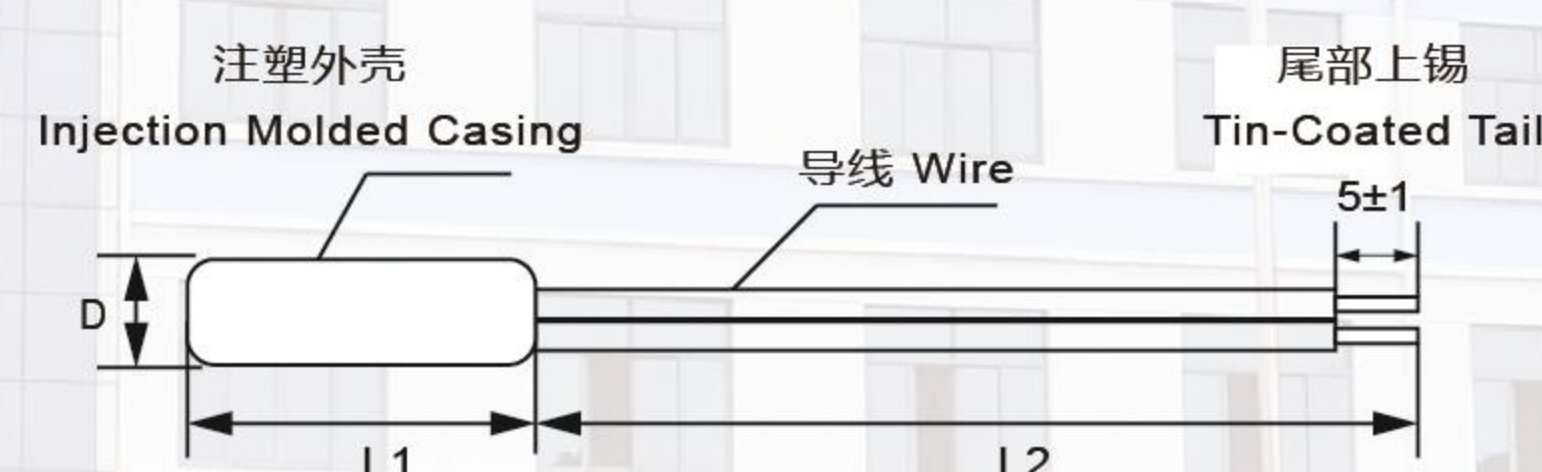

D L1 L2 用户确定 To be determined by the user

CWF7 陶瓷圆柱形  
CWF7 Ceramic Cylinder

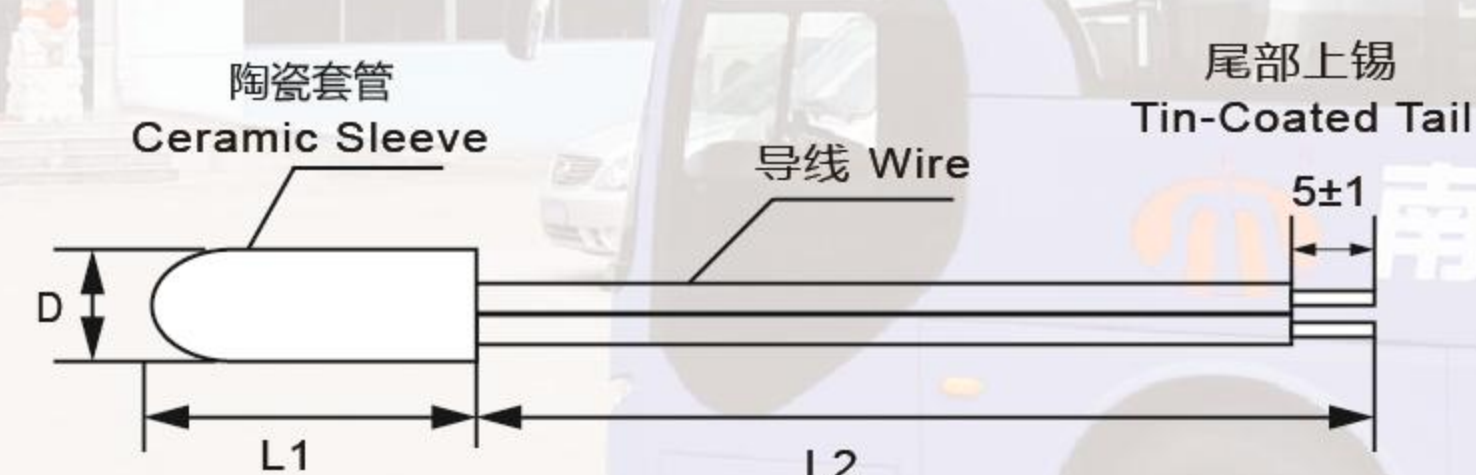

D L1 L2 用户确定 To be determined by the user